

Irshmans

Gas cooktop
user manual

Model: MG 70575
MG 70576

Preface

Thank you for choosing our gas cooktop.

To use this appliance correctly and prevent any potential risk, read these instructions before using the appliance.

Keep these instructions in a place where you can find them easily.

If you are unsure of any of the information contained in these instructions, please contact our customer care centre.

The manufacturer shall not be responsible for any damages to persons or property caused by incorrect installation or use of the appliance.

The appliance has been certified for use in countries other than those marked on the appliance.

The manufacturer also reserves the right to make any modifications to the products as may be considered necessary or useful, also in the interests of the user, without jeopardising the main functional and safety features of the products themselves.

The appliance is designed for a domestic environment and not a commercial one.

These instructions are only valid if the country symbol appears on the appliance.

If the symbol does not appear on the appliance, it is necessary to refer to the technical instructions which will provide the necessary instructions concerning modification of the appliance to the conditions of use of the country.

Prior to installation, ensure that the local distribution conditions (nature of the gas and gas pressure) and the adjustment of the appliance are compatible.

The adjustment conditions for this appliance are stated on the label (or data plate);

This appliance is not connected to a combustion products evacuation device. It shall be installed and connected in accordance with current installation regulations.

Particular attention shall be given to the relevant requirements regarding ventilation.

Preface

Safety Warning

3	Safety Instructions
4	Installation
5	Child and People Safety
6	During Use
8	Cleaning and Service
8	Environmental Information

Instructions for use and maintenance



9	Description of the appliance
12	How to Use the appliance
13	Safety and Energy saving advice
14	Cleaning and Maintenance

Technical instructions

16	Using instructions
17	Positioning
18	Installing the appliance
20	Gas Connection
21	Electrical Connection
22	Gas Conversion
23	Troubleshooting

safety instructions

- Please take the time to read this Instruction Manual before installing or using the appliance.
- This appliance can be used by children aged from 8 years and above and persons with reduced physical, sensory or mental capabilities or lack of experience and knowledge if they have been given supervision or instruction concerning use of the appliance in a safe way and understand the hazards involved. Children shall not play with the appliance. Cleaning and user maintenance shall not be made by children without supervision.
- If the supply cord is damaged, it must be replaced by the manufacturer, its service agent or similarly qualified persons in order to avoid a hazard.
- This instruction booklet must be kept with the appliance for any future reference. If the appliance is sold or transferred to another person, ensure the booklet is passed on to the new user.
- The manufacturer declines any liability should these safety measures not be observed.
- The following marks are made to be easily understood so that you can prevent any accident caused by misuse in advance, and use the appliance more conveniently.
- Read the following contents thoroughly and ensure you understand them.

 Danger/Warning	Neglect of this mark may result in severe personal injury or death.
 Caution	Neglect of this mark may result in minor personal injury or property damage.

■ The following marks are used in the Instruction Manual as follows:



Caution



No Access



No Fire Tool



Must Do



■ If gas seems to leak, take the actions as follow :

- Do not turn on the light.
 - Do not switch on/off any electrical appliance and do not touch any electric plug.
 - Do not use a telephone.
- 1 Stop using the product and close the middle valve.
 - 2 Open the window to ventilate.
 - 3 Contact our service centre by using a phone outside.

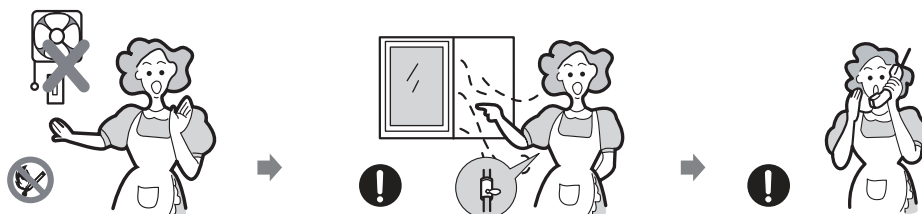

* The fuel gas contains mercaptan, so that you can smell the gas leak (smell of rotten garlic or egg) even where only 1/1000 of the gas is in the air.

Warning

- This appliance shall be installed in accordance with regulations in force and only used in a well ventilated space.

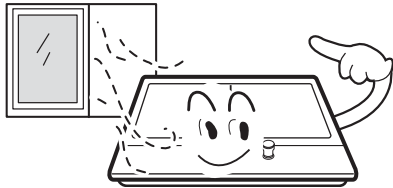

- Prior to installation, ensure that the gas and electrical supply complies with the type stated on the rating plate.



- Where this appliance is installed in marine craft or in caravans, it should not be used as a space heater.

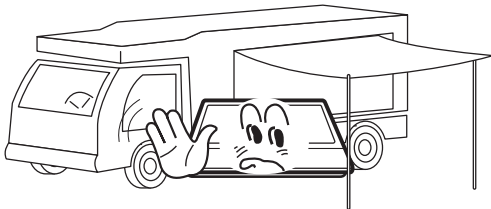

- The gas pipe and electrical cable must be installed in such a way that they do not touch any parts or the appliance.

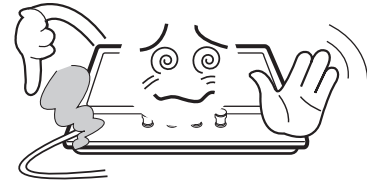

Caution

- This appliance should be installed by a qualified technician or installer.
- The adjustment conditions for this appliance are stated on the label or data plate.
- Remove all packaging before using the appliance.
- After unpacking the appliance, make sure the product is not damaged and that the connection cord is in perfect condition. Otherwise, contact the dealer before installing the appliance.
- The adjacent furniture and all materials used in the installation must be able to withstand a minimum temperature of 85°C above the ambient temperature of the room it is located in, whilst in use.
- In the event of burner flames being accidentally extinguished, turn off the burner control and do not attempt to re-ignite the burner for at least one minute.
- The use of a gas cooking appliance results in the production of heat and moisture in the room in which it is installed. Ensure that the kitchen is well ventilated: keep natural ventilation holes open or install a mechanical ventilation device (mechanical extractor hood).
- Prolonged intensive use of the appliance may call for additional ventilation, for example opening of a window, or more effective ventilation, for example increasing the level of mechanical ventilation where present.

Warning

- Do not allow children to play near or with the appliance.
The appliance gets hot when it is in use.
Children should be kept away until it has cooled.

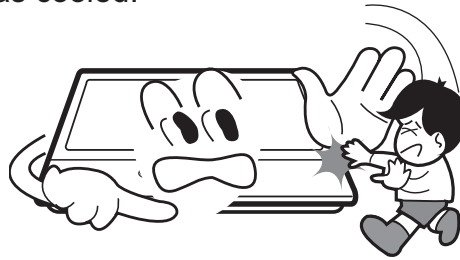

Caution

- This appliance is designed to be operated by adults.
- Children can also injure themselves by pulling pans or pots off the appliance.
- This appliance is not intended for use by children or other persons whose physical, sensory or mental capabilities or lack of experience and knowledge prevents them from using the appliance safely without supervision or instruction by a responsible person to ensure that they can use the appliance safely.

Warning

- Only use the appliance for preparing food.

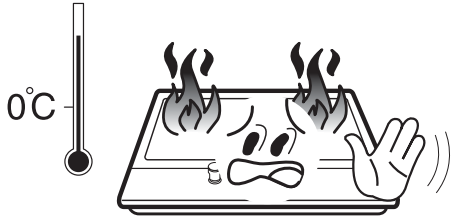

- Do not modify this appliance. Burner panel is not designed to operate from an external timer or separate remote control system.

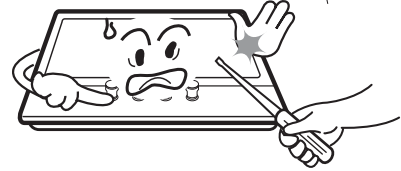

- The use of a gas cooking appliance results in the production of heat and moisture in the room in which it is installed. Ensure that the kitchen is well ventilated : keep natural ventilation holes open or install a mechanical ventilation device (mechanical extractor hood).

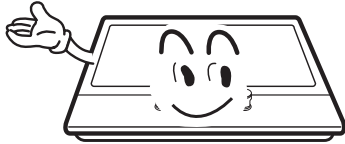

- Do not use this appliance if it comes in contact with water. Do not operate this appliance with wet hands.



- The heating and cooking surfaces of the appliance become hot when they are in use, take all due precautions.



- Do not use large cloths, tea towels or similar as the ends could touch the flames and catch fire.

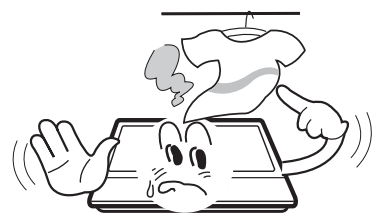

- Never leave the appliance unattended when cooking.



- Unstable or misshapen pans should not be used on the appliance as they can cause an accident by tipping or spillage.



- Do not use or store flammable materials in the storage drawer near this appliance.



- Perishable food, plastic items and aerosols may be affected by heat and should not be stored above or below the appliance.



- Do not spray aerosols in the vicinity of this appliance while it is in operation.



- Ensure the control knobs are in the '●' position when not in use.

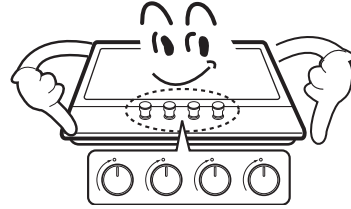

Caution

- Prolonged intensive use of the appliance may call for additional ventilation, for example opening of a window, or increasing the level of mechanical ventilation where present.
- Use heat-resistant pot holders or gloves when handling hot pots and pans.
- Do not let pot holders come near open flames when lifting cookware.
- Take care not to let pot holders or gloves get damp or wet, as this causes heat to transfer through the material quicker with the risk of burning yourself.
- Only ever use the burners after placing pots and pans on them. Do not heat up any empty pots or pans.
- Never use plastic or aluminium foil dishes on the appliance.
- When using other electrical appliances, ensure the cable does not come into contact with the appliance surfaces of the cooking appliance.
- If you have any mechanical parts eg. an artificial heart in your body, consult a doctor before using the appliance.
- Do not use a tea towel or similar materials in place of a pot holder. Such cloths can catch fire on a hot burner.
- When using glass cookware, make sure it is designed for top plate cooking. If the surface is made of glass-cracked, switch off the appliance to avoid defeat electrocution.
- To minimise the possibility of burns, ignition of flammable materials and spillage, turn cookware handles toward the side or center of the top plate without extending over adjacent burners.
- Always turn burner controls off before removing cookware.
- Carefully watch foods being fried at a high flame setting.
- Always heat fat slowly and watch as it heats.
- Foods for frying should be as dry as possible. Frost on frozen foods or moisture on fresh foods can cause hot fat to bubble up and over the sides of the pan.
- Never try to move a pan of hot fat especially a deep fat fryer. Wait until the fat is completely cool.
- In case of hotplate glass breakage:
 - shut immediately off all burners and any electrical heating element and isolate the appliance from the power supply.
 - do not touch the appliance surface,
 - do not use the appliance.
- Hob guards cannot be used. Inappropriate hob guards can cause accidents.
- Avoid using cooking vessels on the hotplate that overlap its edges.

cleaning and service

Warning

- Never use abrasive or caustic cleaning agents.



- This appliance should only be repaired or serviced by an authorised Service Engineer and only genuine approved spare parts should be used.

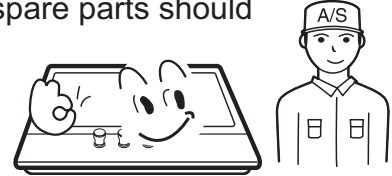

Caution

- Before attempting to clean the appliance, it should be disconnected from the mains and cooled.
- You should not use a steam jet or any other high pressure cleaning equipment to clean the appliance.

environmental information

- After installation, please dispose of the packaging with due regard to safety and the environment.
- When disposing of an old appliance, make it unusable, by cutting off the cable.

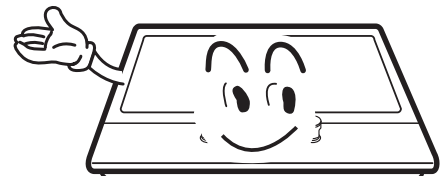

Correct Disposal of This Product (Waste Electrical & Electronic Equipment)

- This marking shown on the product or its literature, indicates that it should not be disposed with other household wastes at the end of its working life. To prevent possible harm to the environment or human health from uncontrolled waste disposal, please separate this from other types of wastes and recycle it responsibly to promote the sustainable reuse of material resources.
- Household users should contact either the retailer where they purchased this product, or their local government office, for details of where and how they can take this item for environmentally safe recycling.
- Business users should contact their supplier and check the terms and conditions of the purchase contract. This product should not be mixed with other commercial wastes for disposal.

description of the appliance

Model	MG 70575 / MG 70576
Type of gas hob	Built-in gas hob
Pan Support	Cast iron
Top Plate	Glass
Dimension(W*D*H)	750*510*90
Ignition device	Continuous Ignition Type
Gas Connection	G1/2 thread
Electric supply	220~240Vac,50Hz-60Hz, 2.0 W
Burner Feature	Wok burner (1), Rapid burner (1) Semi-rapid burner (2), Auxiliary (1)
ΣQ_n	11.5kW

description of the appliance

Burner feature

Category	Gas type	Burner	Wok	Rapid	Semi-Rapid	Auxiliary
		Rated Power(kW)	4.0	3.0	1.75	1.0
I3+	G30/G31 29/37 mbar	Rated Flow(g/h)	291	219	127	73
		Injector Diameter(mm)	1.00	0.87	0.66	0.50
I12H3+	G30/G31 29/37 mbar	Injector Diameter(mm)	1.00	0.87	0.66	0.50
I12E3B/P, I12H3B/P	L.P. G(G30, G31) (28-30) mbar	Injector Diameter(mm)	1.00	0.87	0.66	0.50



- If you want to process gas conversion, all work must be carried out by a qualified technician.
- All injectors replacement should be operated according to the table above.
- After gas conversion, it is strongly suggested to place new label on the product for clarification.
- For operation detail, please refer to Chapter GAS CONVERSION.

description of the appliance

Accessories

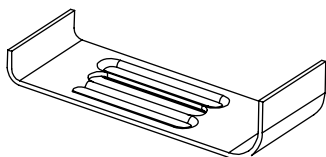

Bracket (4)

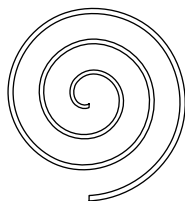

Sponge (4)



Screw (4)



Gas-pipe bend (1)



Instruction Manual (1)

how to use the appliance

The following symbols will appear on the control panel, next to each control handle :

- Black circle: gas off

MAX Large flame: maximum setting

MIN Small flame: minimum setting

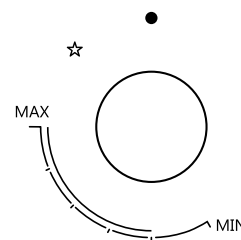

- The minimum setting is at the end of the anti-clockwise rotation of the control handle.
- All operation positions must be selected between the maximum and minimum position.
- The symbol on the control panel, next to the control handle will indicate which burner it operates.

Automatic ignition with flame failure safety device

The appliance is fitted with a flame failure safety device on each burner, which is designed to stop the flow of gas to the burner head in the event of the flame going out.

How to Use the appliance

Automatic ignition with flame failure safety device

The appliance is fitted with a flame failure safety device on each burner, which is designed to stop the flow of gas to the burner head in the event of the flame going out.

1 To ignite a burner

Turn on the power first, then ignite the fire.

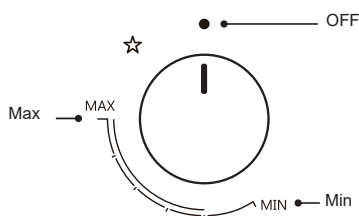

Press the control knob of the burner to be ignited and turn it anti-clockwise to the maximum position, the automatic ignition for the burner will operate.

After the flame on the burner is lit, you can release the control knob.

If the control knob is released, the burner has not lit, stop operating the device and open the compartment door and/or wait at least 1 min before attempting a further ignition of the burner.

2 Adjust the firepower

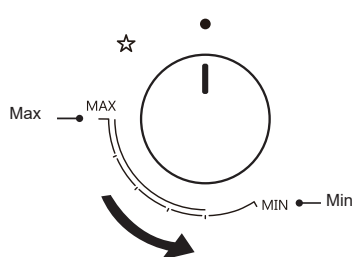

After burner ignition, to adjust the firepower, you should continue turning the control knob anti-clockwise until the flame is at a suitable level. The operating position MUST be at a position between the maximum and minimum position.

3 Flameout

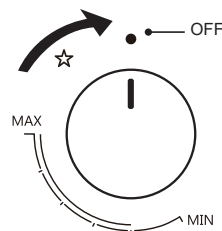

To switch the burner off, turn the control knob fully clockwise to the gas off position.

In case of power failure, the burners can be lit by carefully using a match.

4 Timer setting

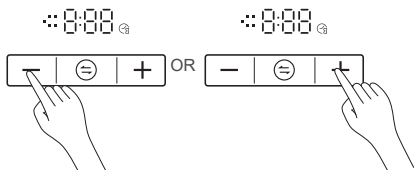

After the ignition is completed, you can set a timer.

Long press on the — or +, enter timer setting, tap the button to set time, short tap to add/reduce 1 minute at a time, long press to quick set, the setting range is 1-180 minutes.

No operation in 5 seconds, the current time will be confirmed.

5 Switch the burner of timer setting

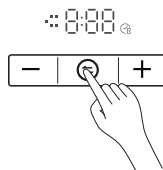

Tap ⊖ to switch the burner that you want to set. Indicator light in the display area shows the burners that can be set and which one you are selecting.

6 Modify current time

If you want to modify the current time, just long press on the — or + again, the timer can be modified by step 4.

7 Cancel timer

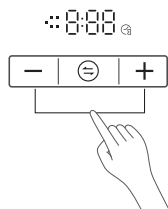

To cancel the scheduled work, long press the — and + at the same time, the timer can be canceled. The burner will keep working as a normal burner.

If you switch the knob to the OFF position like step 3, the timer and the flame will both be off.

8 Timer end



After the countdown is end, the burner will be off, please turn the knob in the OFF position.

The hob will beep to remind you when there is 30 seconds left and after the timer is end.

safety and energy saving advice

- The diameter of the bottom of the pan should correspond to that of the burner.

BURNERS	PANS	
	min.	max.
Triple-Crown	200mm	260mm
Rapid	180mm	220mm
Semi-Rapid	180mm	200mm
Auxiliary	120mm	180mm



■ Do not use cookware that overlaps the edge of the burner.

NO		YES	
	Do not use small diameter cookware on large burners. The flame should never come up the sides of the cookware.	Always use cookware that is suitable for each burner, to avoid wasting gas and discolouring the cookware.	
	Avoid cooking without a lid or with the lid half off - as this wastes energy	Place a lid on the cookware.	
	Do not use a pan with a convex or concave bottom.	Only use pots, saucepans and frying pans with a thick, flat bottom.	
	Do not place cookware on one side of a burner, as it could tip over.	Always place the cookware right over the burners, not to one side.	
	Do not use cookware with a large diameter on the burners near the controls, which when placed on the middle of the burner may touch the controls or be so close to them that they increase the temperature in this area and may cause damage.		
	Never place cookware directly on top of the burner.	Place the cookware on top of the trivet.	
	Do not place anything, eg. flame tamer, asbestos mat, between pan and pan support as serious damage to the appliance may result.		
	Do not use excessive weight and do not hit the cooktop with heavy objects.	Handle cookware carefully when they are on the burner.	



■ It is not recommended to use roasting pans, frying pans or grill stones heated simultaneously on several burners because the resulting heat build-up may damage the appliance.

■ Do not touch the top plate and trivet whilst in use for a certain period after use.











■ As soon as a liquid starts boiling, turn down the flame so that it will barely keep the liquid simmering.

cleaning and maintenance



- Cleaning operations must only be carried out when the appliance is completely cool.
- The appliance should be disconnected from your mains supply before commencing any cleaning process.
- Clean the appliance regularly, preferably after each use.
- Abrasive cleaners or sharp objects will damage the appliance surface; you should clean it using water and a little washing up liquid.

Usable	Unusable
 Soft cloth  Neutral Detergent	 Nylon Brush  Edible Oil  Abrasive  Metal Brush  Acidic/Alkali Detergent  Thinner/Benzene

Pan support, Control handles

- Take off the Pan support.
- Clean these and the control handles with a damp cloth, washing up liquid and warm water. For stubborn soiling, soak beforehand.
- Dry everything with a clean soft cloth.

Top plate

- Regularly wipe over the top plate using a soft cloth well wrung-out in warm water to which a little washing up liquid has been added.
- Dry the top plate thoroughly after cleaning.
- Thoroughly remove salty foods or liquids from the hob as soon as possible to avoid the risk of corrosion.
- Stainless steel parts of the appliance may become discoloured over time. This is normal because of the high temperatures. Each time the appliance is used these parts should be cleaned with a product that is suitable for stainless steel.

BURNERS

- Remove the burner lids and Flame Spreaders by pulling them upwards and away from the top plate.
- Soak them in hot water and a little detergent or washing up liquid
- After cleaning and washing them, wipe and dry them carefully. Make sure that the flame holes are clean and completely dry.
- Wipe the fixed parts of the burner cup with a damp cloth and dry afterwards.
- Gently wipe the ignition device and flame supervision device with a well wrung-out cloth and wipe dry with a clean cloth.
- Before placing the burners back on the top plate, make sure that the injector is not blocked.

■ Re-assemble the Auxiliary, Semi-Rapid, Rapid and Triple-Crown burners as follows :

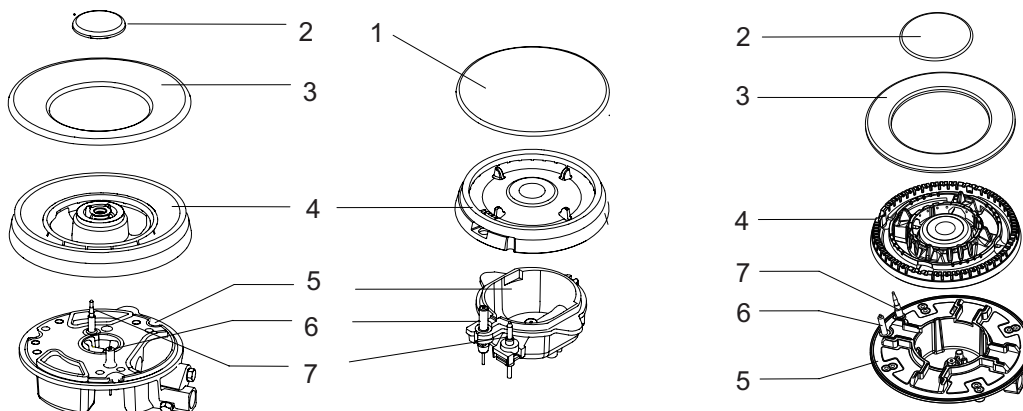

1. Place the flame spreader (4) on to the burner cup (5) so that the ignition device and the flame supervision device extend through their respective holes in the flame spreader.
The flame spreader must click into place correctly.
2. Position the burner lid (1 , 2 , 3) onto the flame spreader (4) so that the retaining pins fit into their respective recesses.



Replace parts in the correct order after cleaning.

- Do not mix up the top and bottom.
- The locating pins must fit exactly into the notches.

Warnings

- Do not modify this appliance.
- This appliance must be installed by an authorised technician or installer.
- Prior to installation, ensure that the local distribution conditions (nature of the gas and gas pressure) and the adjustment of the appliance are compatible.
- The adjustment conditions for this appliance are stated on the label (or data plate).
- This appliance is not connected to a combustion products evacuation device. It should be installed and connected in accordance with current installation regulations. Particular attention should be given to the relevant requirements regarding ventilation.
- Before installing, turn off the gas and electricity supply to the appliance.
- All appliances containing any electrical components must be earthed.
- Ensure that the gas pipe and electrical cable are installed in such a way that they do not touch any parts of the appliance which may become hot.
- Gas pipe or connector shouldn't be bent or blocked by any other appliances.
- Check the dimensions of the appliance as well as the dimensions of the gap to be cut in the kitchen unit.
- The panels located above the work surface, directly next to the appliance, must be made of non-flammable material. Both the stratified surfacing and the glue used to secure it should be heat resistant, to prevent deterioration.
- Turn on appliance tap and light each burners.
Check for a clear blue flame without yellow tipping.
If burners shows any abnormalities check the following :
 - Burner lid on correctly
 - Flame spreader positioned correctly
 - Burner vertically aligned with injector nipple
- A full operational test and a test for possible leakages must be carried out by the fitter after installation.
- The flexible hose shall be fitted in such a way that it cannot come into contact with a moveable part of the housing unit and does not pass through any space susceptible of becoming congested.
- Grease cranes produced at the factory to meet the requirement of all life hob.

Cut-Out

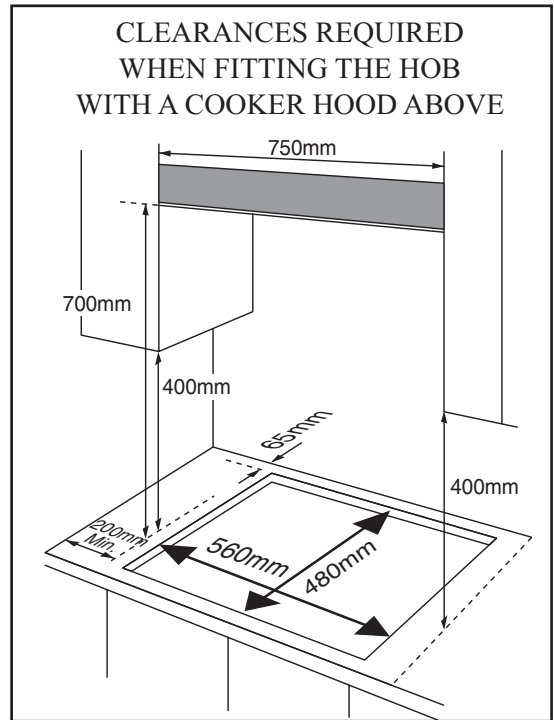
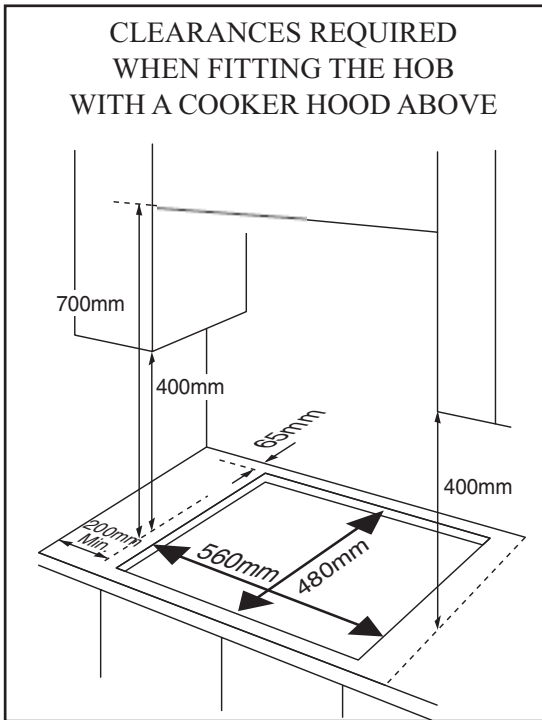

installing the appliance

■ **This appliance is to be built into a kitchen unit or 600 mm worktop, providing the following minimum distances are allowed ;**

- The edges of the hob must be a minimum distance of 65mm from rear wall and 200mm from side wall
- 700 mm between the highest point of the hob surface (including the burners) and the underside of any horizontal surface directly above it.
- 400 mm between the hob surfaces, providing that the underside of the horizontal surface is in line with the outer edge of the hob. If the underside of the horizontal surface is lower than 400 mm, then it must be **at least** 50 mm away from the outer edges of the hob.
- 50 mm clearance around the appliance and between the hob surface and any combustible materials.
- You must have a gap of at least 25 mm and at most 74 mm between the underneath of the appliance and any surface that is below it.

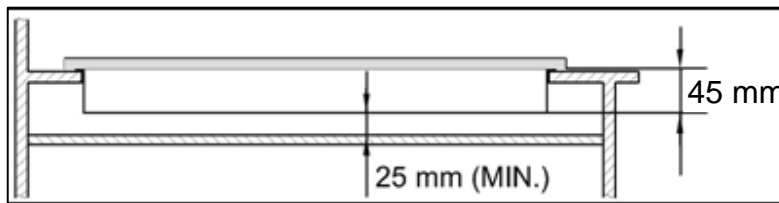

With Glass hob

To prevent leakage of liquid between the frame of the hob and the countertop, place the adhesive seal provided along the entire outer edge of the hob before assembly.

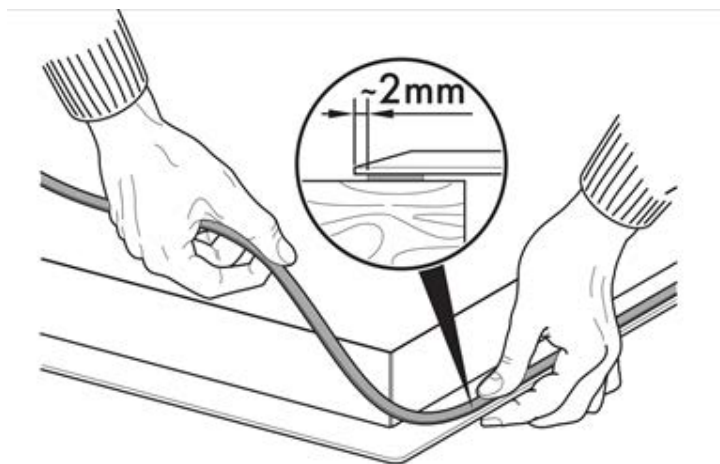

installing the appliance

With Steel hob

To prevent leakage of liquid between the frame of the hob and the work surface, put the insulating seal provided in position before assembly.

1. Install the product into countertop and use a pencil to draw a line along the product outer edges.
2. Take out the product and place the adhesive seal provided along the line you draw by step 1. Use light pressure to make the seal stick to the worktop.
3. Install the product again, Use light pressure to make the seal stick to product edge.
4. Carefully trim the surplus edge away from the seal.
5. Cleaning.

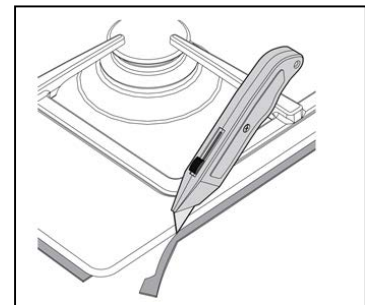
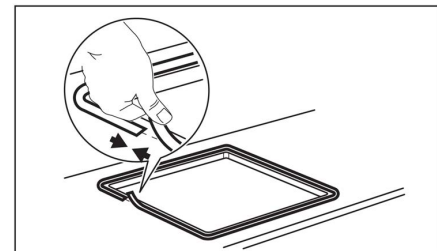
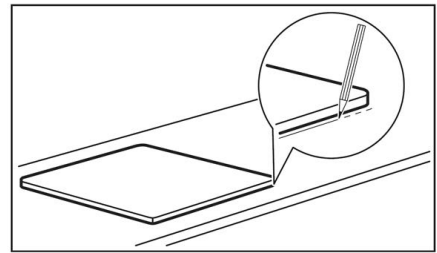

Do not use a silicon sealant to seal the appliance against the aperture.

This will make it difficult to remove the appliance from the aperture in future, particularly if it needs to be serviced.

1. Place the bracket (B) over the holes that match the size of the screws. There are one set of screw holes in each corner of the hob(H). Slightly tighten a screw (C) through the bracket (B) so that the bracket is attached to the hob, but so that you can still adjust the position .
2. Carefully turn the hob back over and then gently lower it into the aperture hole that you have cut out.
3. On the underneath of the hob, adjust the brackets into a position that is suitable for your worktop. Then fully tighten the screws(C) to secure the hob into position.

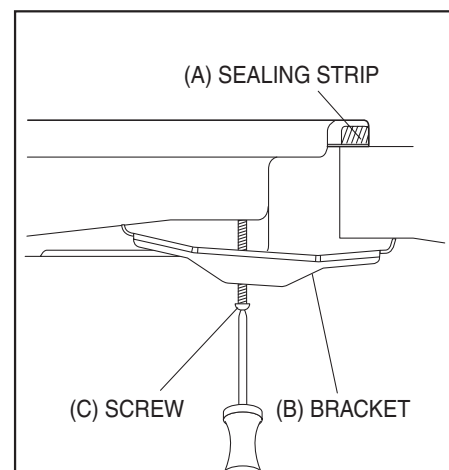
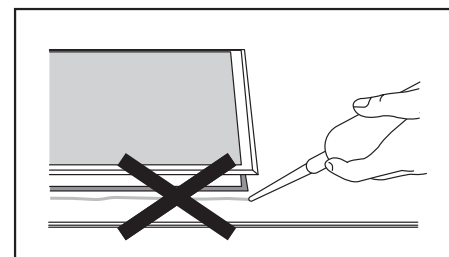

gas connection



- This appliance must be installed and connected in accordance with installation regulations in force in the country in which the appliance is to be used.
- This appliance is supplied to run on LPG and natural gas . Conversion for use on LPG and natural gases must only be undertaken by a qualified person.

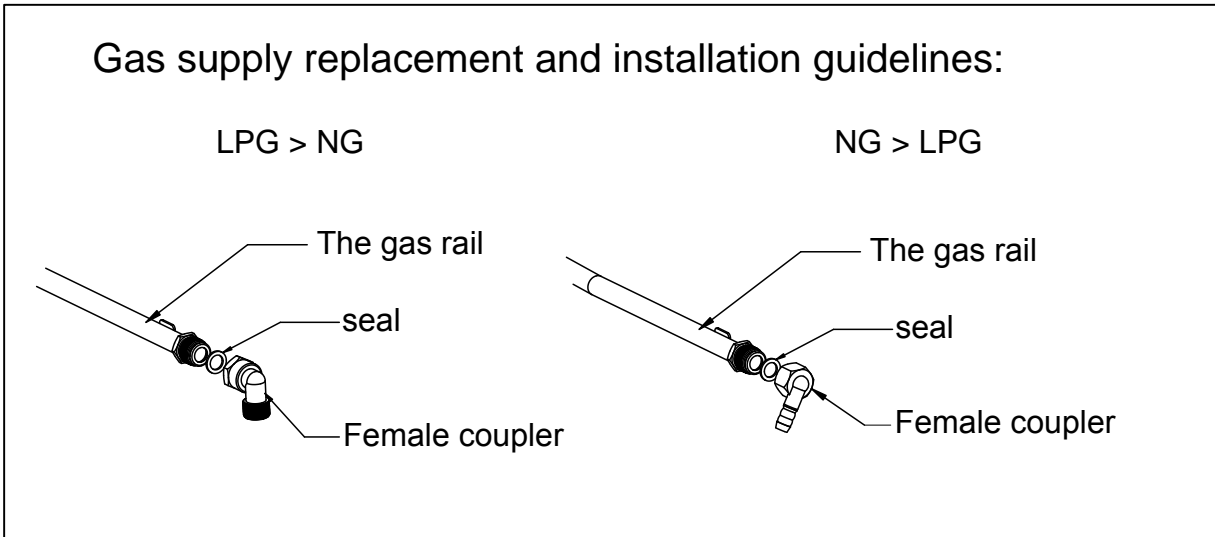

- It is the law that all gas appliances are installed by competent persons in accordance with the current edition of the Gas Safety Installation and Use Regulations .
- It is in your interest and that of safety to ensure compliance with the law.
- In the UK, GASSAFE registered installers work to safe standards of practice. The hob must also be installed in accordance with the current edition of BS 6172. Failure to install the cooker correctly could invalidate the warranty, liability claims and lead to prosecution.

I3+(28-30/37)	G30 Butane at 28-30mbar and G31 Propane at 37mbar	BE, CH, CY, CZ, ES, FR, GB, GR, IE, IT, LT, LU, LV, PT, SK, SI
I3B/P(30)	G30 Butane and G31 Propane at 30mbar	BE, CY, DK, EE, FR, GB, HU, IT, LT, NL, NO, SE, SI, SK, RO, HR, TR, BG, IS, LU, MT, FI
I2H/I2E/I2E+√	G20 Methane at 20mbar	AT, CH, CZ, DK, ES, FI, GB, GR, IE, IS, IT, PT, SE, SI, SK, DE, LU, GE, FR
II2H3+	G20 at 20mbar, G30 Butane at 28-30mbar and G31 Propane at 37mbar	CH, CZ, ES, GB, GR, IE, IT, PT, SI

electrical connection

- This appliance must be earthed.
- This appliance is designed to be connected to a 220-240V, 50Hz-60Hz AC electricity supply.
- The wires in the mains lead are coloured in accordance with the following code ;
 - Green/yellow = Earth
 - Blue = Neutral
 - Brown = Live



- **The wire which is coloured green and yellow must be connected to the terminal which is marked with the letter E or by the earth symbol.**



- Take precautions on the operations and adjustments to be carried out when converting from one gas to another.
- All work must be carried out by a qualified technician.
- Before you begin, turn off the gas and electricity supply to the appliance.

1 Change the injector of the burners.

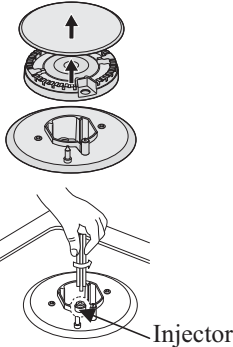

Remove the pan support, Burner lid and Flame spreader.

Unscrew the injector using a 7 mm box spanner and replace it with the stipulated injector for new gas supply.

Carefully reassemble the all components.

After injectors are replaced, it is advisable to strongly tighten the injector in place.

2 Adjustment of minimum level of the flame

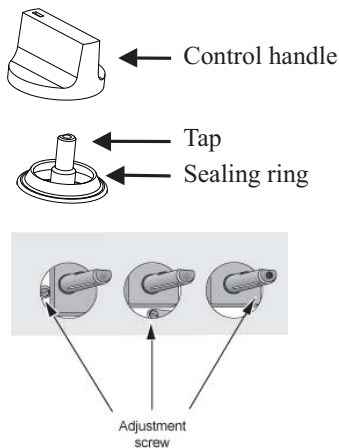

- ① Turn the taps down to minimum
- ② Remove the knob from the tap and place a small bladed screwdriver in the centre of the tap shaft.
- ③ The correct adjustment is obtained when the flame has a length of about 3 - 4 mm.
 - For butane/propane gas, the adjusting screw must be tightly screwed in.
 - Refit the control knob.
 - Make sure that the flame does not go out by quickly turning from maximum flow to minimum flow. If it does then remove the control knob and make further adjustments to the gas flow, testing it again once the adjustment has been made.
- ④ Repeat this process for each one of the gas taps.



- Do not dismantle the tap shaft : in the event of a malfunction, change the whole tap.
- Before placing the burners back on the top place, make sure that the injector is not blocked.
- A full operational test and a test for possible leakages must be carried out after gas conversion. (such as soap water or gas detector)
- After completing conversion, a qualified technician or installer has to mark "V" on the right gas category to match with the setting in rating plate. Remove the previous setting "V" mark.

trouble shooting

- Repairs should be performed by a licensed technician only. Improper repair may result in considerable danger to you and others.
- However, some minor problems can be resolved as follows :

Problem	Probable cause	Solution
Not ignited	No Spark.	Check the electricity supply.
	The burner lid is badly assembled.	Assemble the lid correctly.
	The gas supply is closed.	Open the gas supply completely.
Badly ignited	The gas supply is not completely open.	Open the gas supply completely.
	The burner lid is badly assembled.	Assemble the lid correctly.
	The ignition plug is contaminated with alien substance.	Wipe alien substance with a dry cloth .
	The burners are wet.	Dry the burners lids carefully.
	The holes in the flame spreader are clogged.	Clean the flame spreader.
Noise made when combusted and ignited	The burner lid is badly assembled.	Assemble the burner lid correctly.
Flame goes out when in use.	The flame supervision device is contaminated with alien substance.	Clean the flame supervision device.
	Product being cooked has boiled over and extinguished the flame.	Turn off burner knob. Wait one minute and reignite zone.
	A strong draught may have blown the flame out .	Please turn off zone and check cooking area for draught such as open windows. Wait one minute and reignite zone
Yellow Flame	The holes in the flame spreader are clogged.	Clean the flame spreader.
	Different gas is used.	Check the gas used.
Unstable Flame	The burner lid is badly assembled.	Assemble the burner lid correctly.
Gas Smell	Gas leakage	Stop using the product and close the middle valve. Open the window to ventilate. Contact our service centre by using a phone outside.



- If problem is not solved, please contact customer care center.

הוראות התקנה ומידות

חל איסור להתקין את הכיריים לבד. חיבור הכיריים לצינור הגז יעשה אך ורק ע"י מתקין מקצועי מטעם היבואן עם רישיון להתקין ולתקן מכשירי גז.

יש להכין את הפתח בשיש בהתחשב שמרחקים מהקיר והארון כמפורט למטה. בשרטוט למטה יש את מידות הפתח שיש להכין על מנת להתקין את הכיריים במשטח העבודה. ואת המרחקים שיש להשאיר בין הכיריים לקיר ולארון.

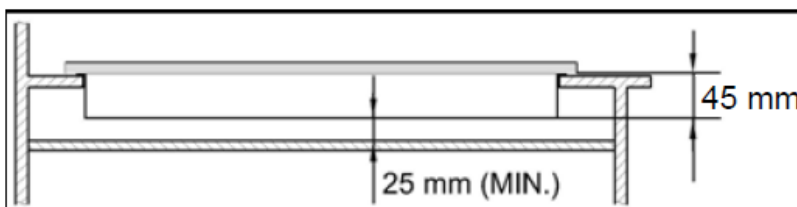
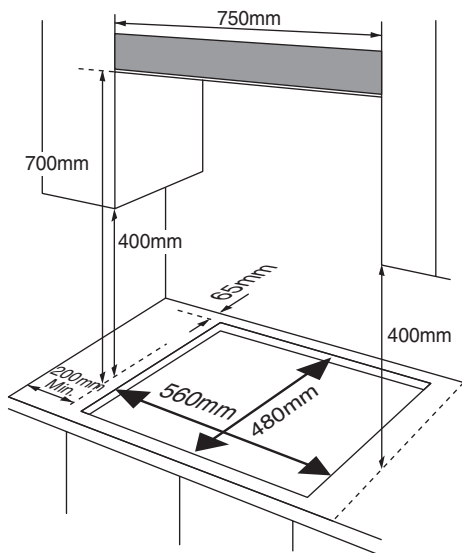

יש להשאיר חלל מתחת לכיריים של מינימום 25 מ"מ.

לפני הכנסת הכיריים למקומם יש להדביק את פס האטימה על תחתית הכיריים או מסביב לפתח בשיש

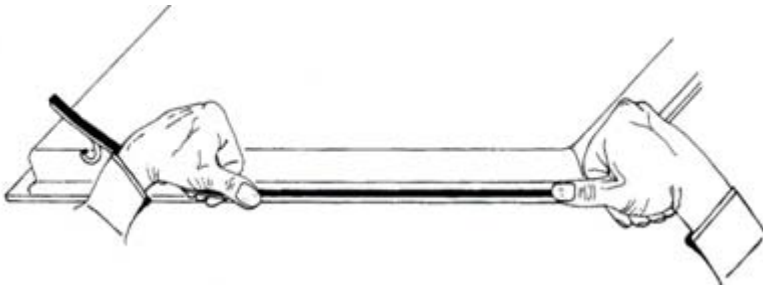

הוראות ניקוי כיריים גז משטח אמאייל או נירוסטה

זכרו, חומר ניקוי חריפים (מסירי שמנים לסוגיהם) ומים רבים תוקפים את הכיריים, יוצרים נזקים בלתי הפיכים, ומקצרים את חיי הכיריים, מאחר והם גורמים לבלאי מואץ. הניקוי יעשה כאשר הכיריים קרות בלבד.

לפני הניקוי מומלץ לנתק את הכיריים מהחשמל.

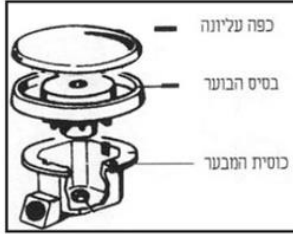

את משטח האמאייל או הנירוסטה מומלץ לנקות במטלית רכה ולחה, ובדטרגנט רגיל (המשמש לניקוי כלים) בשום אופן אין להשתמש בצמר פלדה או סקוטשברייט לניקוי המשטח – מוצרים אלו גורמים לשריטות במשטח האמאייל והנירוסטה.

על משטח נירוסטה רצוי להגן אחרי הניקוי בעזרת נירוסטון (ראה בסוף חוברת זו)

אסור להרתיח את חלקי הבער, ואין להכניסם למדיח כלים.

גלישת נוזלים על משטח העבודה לתוך כוסיית המבער יש לייבש ולנגב מיידית לפני המשך הבישול. כתמי שומן יש לנגב מיד ולא לאפשר להם "להתבשל" ולהתקשות על משטח העבודה. את רשתות הגז יש לנקות עם מטלית לחה ונוזל כלים, ולייבש מיידית היטב. אין להכניס את הרשתות גז למדיח כלים. רשתות יציקה כבדה יש לשמן בחלק התחתון היכן שאין ציפוי אמאייל. את הכוסיית (היכן שנמצא נחיר הגז) יש לנגב היטב.

בגמר הניקוי יש לפתוח ולסגור את כפתור הגז, כדי לנקות את נחיר הגז. את הבער המחולק לשניים יש לנקות כדלהלן: החלק התחתון (בסיס הבער) העשוי אלומיניום יש להשרות במים חמים (לא להרתיח) ואחר כך לשפשף עם צמר פלדה או סקוטשברייט ונוזל כלים, ולייבש היטב.

את החלק העליון (כפה) המצופה אמאייל בחלקו העליון, יש לשטוף כאשר הוא קר במים פושרים, מטלית רכה ולחה, ונוזל כלים, לנגב היטב, ואף חובה לשמן את חלקו התחתון (הצד ללא האמאייל) עם שכבת שמן דקה כדי למנוע נקודות חלודה. בכל מקרה אין להשאירו רטוב שיתייבש לאט. במידה ומופיעים כתמי חלודה בחלק התחתון של הכפה, יש לשפשף עם צמר פלדה כדי להוריד את החלודה ולשמן כמומלץ.

יש להזהר לא להרטיב אל ברז הגז, ולא לאפשר לנוזלים ולחומרי ניקוי להגיע אליו, כדי למנוע קורוזיה בברז הגז. מומלץ לאחר הניקוי להרכיב את חלקי הבער ולהדליק את האש כדי לייבש את חלקי הבער.

היטב את המטבח ולהזמין את טכנאי השירות.

15. אין להרכיב את הכיריים בצמוד לארון עץ, יש לשמור על מרחק נאות כדי למנוע נזק לארון.

16. אין לשים על משטח הכיריים נייר אלומיניום מכל סוג שהוא.

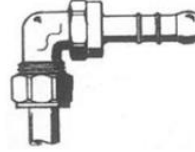

17. אין בשום אופן להזיז או לסובב את פין כניסת הגז בכיריים מחשש לדליפת גז.

18. בכיריים עם משטח עבודה זכוכית:

- אסור להפעיל עם סיר ריק.
- יש להיזהר שזכוכית לא תקבל מכה ממוקדת.
- אסור להניח פח שטוח על כל הכירה ולהפעיל (כפלטה לשבת).
- אסור לצלות חצילים ישירות על הלהבה.

19. אסור לשפשף או להתיז מסיר שומנים או כל חומר חריף אחר על הסימונים שליד הכפתורים, אחרת הסימונים ימחקו.

20. הזהרו לא לאפשר בעת הניקיון למים לגלוש פנימה לתוך הכירה. אין להשתמש במים רבים בעת הניקוי, אלא להשתמש במטלית לחה.

השימוש בבוטרי הגז

לכל סוגי הכיריים



לכל כפתור הפעלה יש סימן המראה איזה בוער הוא מפעיל.

לפני הפעלת הבער יש להניח מעליו כלי בישול כדי להקל על הצתת הלהבה.

ללחוץ על כפתור ההפעלה ולסובב אותו, עד סימון להבה מקסימלית. יש להשאיר את הכפתור לחוץ למשך מספר שניות עד אשר חיישן החום מחמם אחרת הלהבה תכבה ואז יש להתחיל את הפעולה מתחילתה.

לכפתור ההפעלה יש מצב להבה גבוהה ומצב להבה קטנה.

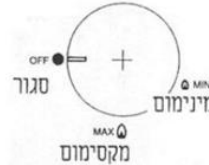

ניתן לווסת את הלהבה לאחר ההדלקה גם בין שני המצבים הללו.

חשוב להתאים את גודל הסיר לגודל הלהבה בכדי לא לבזבז אנרגיה, ועל מנת לא להאיט את קצב הבישול.



לכיבוי הלהבה יש לסובב את הכפתור עד לסימן הסגירה.

בוער הטורבו הנפול (טורבו) הינו לשימוש ייעודי-מיוחד כמו ווק להקפצה, או להרתחה מהירה ונדומה. בשימוש במחבת לזוק חובה להשתמש בטבעת הגבהה שמרחיקה את הסיר מהבער. אין להשתמש בבער זה לבישול ארוך. בישול ארוך או בישול במחבת לזוק ללא טבעת הגבהה, עלולים לגרום לעיוות הבער אשר אינו מכוסה באחריות.

אנו מברכים אתכם על שרכשתם מוצר מבית "קופר יבוא". המוצר שרכשתם מיוצר ממיטב החומרים ולפי תקני בטיחות ואיכות בינלאומיים. מוצר זה אמור לשרת אתכם שנים רבות, לכן הקפידו לקרוא בעיון את כללי הבטיחות והזהירות, ואת הוראות הניקוי והתחזוקה, ולפעול לפיהן. להזכירכם, שימוש נכון ותחזוקה נאותה יאריכו את חיי המוצר, ויחסכו מכם עוגמת נפש והוצאות מיותרות.

**לידיעתכם – שימוש בכלי בישול בעלי תחתית אלומיניום
גורמים לפס כסוף על רשתות האמאייל של הכיריים.
לכן רצוי להשתמש בסירים עם תחתית נירוסטה.**

רשת גז יציקה כפרית אשר ניתז עליה שמן חם נשארת עם כתמים שלא יורדים וזהו בלא טבעי של הרשת.

כ ל ל י ז ה י ר ו ת

ההרכבה, ההתקנה, הפעלה הראשונית ותיקון המכשיר ייעשו רק ע"י מתקין גז מוסמך מטעם משרד העבודה

אם פתיל הזינה ניזוק, כדי להימנע מסכנה, החלפתו תיעשה אך ורק ע"י טכנאי מוסמך מטעם היבואן.

- יש לחבר את המכשיר אך ורק לשקע חשמלי מתאים המחובר לארקה לפי הוראות חברת החשמל.
- יש לחבר את המכשיר ישירות לשקע שבקיר, אין להשתמש בכבל מאריך, במקרה שאין אפשרות כזאת, יש להזמין חשמלאי מוסמך כדי להסדיר חיבור מתאים ובטוח.
- חיבור הכיריים לברז הגז יעשה עם צינור גמיש חדש, המתאים לתקן, והמיועד לחיבורי גז. אין להשתמש בצינור ישן, סדוק פגום או יבש. יש להקפיד להלביש את הצינור על הפין המחבר בכיריים ובברז הגז, כך שיכסה את הפין למלוא אורכו.
- הכנסת התקע החשמלי והוצאתו חייבות להתבצע בידיים יבשות, כאשר הריציפה יבשה, ולא יחפים.
- לפני כל טיפול ותחזוקה של הכיריים, יש לסגור את ברז הספקת הגז ולהוציא את התקע החשמלי.
- בכל מקרה שיש צורך להזיז את הכיריים ממקומם יש לפני כן להוציא את תקע החשמל, ולסגור את ברז הספקת הגז לכיריים. בעת הזזת הכיריים יש להזהר לא למתוח ולא לפגוע בצינור הגז הגמיש, המחבר את הכיריים לברז הגז. אם מסיבה כלשהי מנתקים את הצינור הגמיש מהכיריים, יש להחזירו למקומו תוך הקפדה על הרכבתו המלאה על גבי הפין המחבר, כך שיכסה את הפין למלוא אורכו.
- אם הבחנתם בסדקים, יובש, או פגמים בצינור הגז הגמיש, יש להחליפו מיידית בצינור אחר המתאים לתקן המיועד לחיבור מתקני גז.
- השתמשו בכלי בישול מתאימים בגודלם לרשתות הגז, כדי שיהיו יציבים על גבי הכיריים, ובכך תמנעו התהפכות תבשיל לוחט. אסור להניח כלי בישול קטנים מהפתח שבין הזרועות של רשת הגז ישירות על המבער עצמו.
- הקפידו על ניקיון המבערים כדי לאפשר בעירה נכונה ותיקנה.
- בכל מקרה שלהבת הגז כבתה שלא במתכוון, יש לפעול כלהלן:
 - סיגרו את ברז הגז הראשי במטבח.
 - אוווררו היטב את המטבח ובידקו (ע"י הרחה) המצאות גז באיזור הכיריים.
 - נסו לגלות את הסיבה בגינה כבתה הלהבה: רוח, גלישת תבשיל, חוסר גז וכו'.
 - אם הלהבה כבתה בגלל גלישת תבשיל, יש לנקות את המבער לפני הדלקת הלהבה שנית.
 - בכל מקרה אין לנסות ולהדליק מיידית את הלהבה לפני איזור המטבח, מחשש לפיצוץ.
- הזהרו והרחיקו ילדים מהכיריים, אל תאפשרו להם לשחק בכפתורים גם כאשר הכיריים אינם בשימוש.
- בכל מקרה של תקלה הן במערכת החשמל והן במערכת הגז, פנו ישירות למחלקת השירות. אין לטפל לבד באיתור התקלה או בתיקונה. זיכרו – דליפת גז קטנה ביותר יכולה לגרום לפיצוץ ולנזק רציני.
- בזמן השימוש בכיריים, חובה להשאיר פתח איזור במטבח.**
- במקרה של דליפת גז יש להפסיק מיידית את השימוש בכיריים, לסגור את ברז הגז הראשי, לאוורר

ט ב ל ת א נ ר ג י ה

צריכת הגז בלהבה מקסימלית (גר' לשעה)	צריכת הגז בלהבה חסכונית (גר' לשעה)	קוטר הסיר המומלץ (ס"מ)	קוטר המבער (ס"מ)	מס' המבער ⊗
219	72	22	10	1
73	24	13	5.7	2
127	42	15	7.7	3
291	84	22	13.3	4
837	183.8			סה"כ

מקרא לטבלה: זיהוי המבערים לפי הטבלה

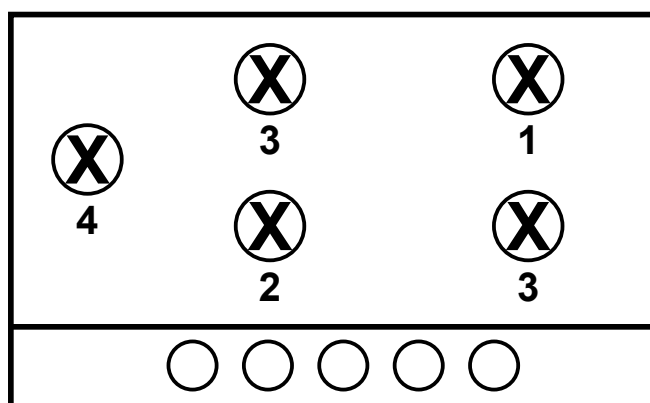

דגמים: MG 70575 / MG 70576

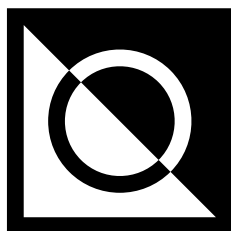

Irshmans

הוראות הפעלה לכיריים גז

דגם :

MG 70575

MG 70576

לחיבור הכיריים למערכת הגז (בתשלום) חובה להזמין טכנאי גז מוסמך מתחנת

השרות של החברה. חיבור ע"י טכנאי לא מורשה עלול לגרום לדליפה ופיצוץ.

חיבור ע"י טכנאי לא מורשה מבטל את האחריות.

לפני הפעלת המכשיר יש לקרוא בעיון את הוראות השימוש, הניקוי והבטיחות ולפעול לפיהם.

שימו לב !

מכשיר זה אינו מיועד לשימוש על ידי אנשים (כולל ילדים) עם יכולות פיזיות, חושיות או שכליות מופחתות, או עם העדר ניסיון וידע. אלא אם הם תחת פיקוח או שקיבלו הנחיות לשימוש במכשיר על ידי האדם האחראי לבטיחותם.
ילדים צריכים להיות תחת השגחה, כדי להבטיח, שהם לא משחקים עם המכשיר.



קופר יבוא 1992 בע"מ

המלאכה 4 פארק אפק אזור התעשייה החדש ראש העין 48091 **טלפון: 03-9381695 פקס: 03-9381696**
4 Hamelacha St. New Industrial Area Rosh-Haayin, code 48091 **Tel. 03-9381695 Fax. 03-9381696**